

LIFTF系列 产品手册

LIFTF Series
Product Manual



关于艾迈斯电子 About Amass

艾迈斯电子（XT系列原创者）始创于2002年，是一家集设计、研发、制造、销售于一体的**国家级专精特新“小巨人”企业和国家级高新技术企业**。专注低压大电流连接器24年，深耕小动力智能设备领域。

公司位于江苏省武进区礼嘉镇，生产面积30000+平方米，土地拥有独立自主产权，500余人的研发、制造及销售团队。百余款连接器产品满足园林工具、储能设备、电动车、智能家电、智能机器人及航模无人机等应用场景的连接器需求；同时提供高效的产品研发和生产服务，为行业客户提供 7A 全周期解决方案。

企业使命：推动低压动力连接产业链运营效率倍增，持续降低低压动力连接领域综合成本。

Amass Electronics (Originator of the XT series) was founded in 2002. It is a national specialized and innovative "Little Giant" enterprise and a national high-tech enterprise integrating design, research and development, manufacturing, and sales. It has focused on low-voltage high-current connectors for 24 years and has deeply cultivated the field of small power intelligent devices.

The company is located in Lijia Town, Wujin District, Jiangsu Province, with a production area of 30,000 square meters and independent land ownership. It has a research, manufacturing, and sales team of over 500 people. More than a hundred connector products meet the connection needs of applications such as garden tools, energy storage equipment, electric vehicles, smart home appliances, intelligent robots, and model drones. At the same time, the company provides efficient product development and manufacturing services, offering 7A full-cycle solutions to industry clients.

Corporate mission: Promote the doubling of operational efficiency in the low-voltage power connection industry chain, and continuously reduce the overall costs in the field of low-voltage power connections.

2002 年	30000 +平	10000 +	100000000 +
成立时间	厂房面积	项目案例	累计装机量
FOUNDED	PLANT AREA	PROJECT EXAMPLES	CUMULATIVE INSTALLED CAPACITY

■ 智慧园区 Smart Park

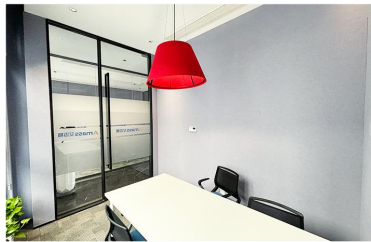

■ 办公会议区 Office meeting area

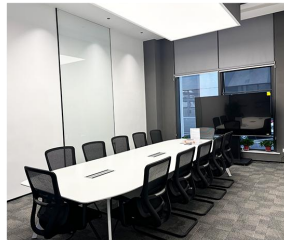

■ 生产仓储区 Production and Storage Area



企业荣誉 Corporate honors

国家级专精特新“小巨人”企业、国家级高新技术企业

It is a national-level specialized and new "little giant" enterprise and a state-level high-tech enterprise.



资质证书 Qualifications

多专利 拥有200+项国家专利证书

Multiple patents. Having over 200 national patent certificates.



多认证 产品通过UL/CE/ROHS等国际认证

Multi-certification. The products have passed UL/CE/ROHS and other international certifications.

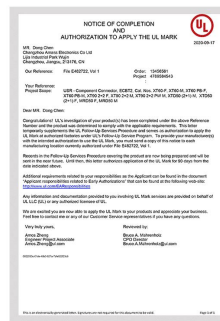

低压大电流连接器应用

Low-voltage high-current connector applications

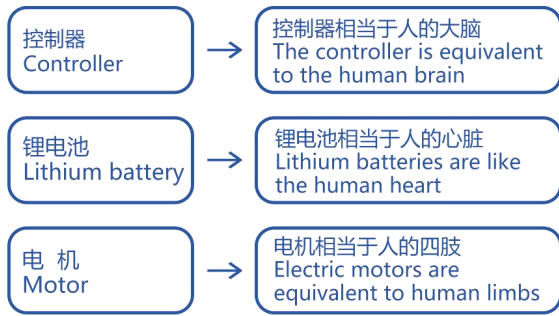

一站式研发能力

One stop R&D capability

研发能力，24年如一日，专注于低压大电流动力连接的技术与经验，只要您提出概念、想法、使用参数等，或者我司现有产品的不足，就可快速的为您提供清晰完整的解决方案。

With 24 years of research and development capabilities, we focus on the technology and experience of low-voltage high current power connections. As long as you propose concepts, ideas, usage parameters, or the shortcomings of our existing products, we can quickly provide you with clear and complete solutions.



低压大电流连接器相当于人的大动脉，保证生命线的畅通
The low-voltage high-current connector is equivalent to the human artery to ensure the smooth flow of the lifeline

应用行业 Application industry

园林工具 Garden tools

- 吹风机
Air blower
- 扫雪机
Snowplow
- 电链锯
Electric chainsaw
- 推草机
Lawn mower
- 高枝锯
High branch saw



电动车 Electric vehicle

- 两轮电动车
Electric vehicle
- 换电柜
Battery swap cabinet
- 平衡车
Balanced vehicle
- 平衡轮
balance wheel
- 电动滑板车
electric scooter



智能机器人 intelligent robot

- 机器狗
robotic dog
- AGV/AMR
- 商用清扫机器人
Commercial Cleaning robot
- 泳池清洁机器人
Swimming pool cleaning robot
- 人形机器人
Humanoid robot



无人机 UAV

- 消费无人机
Consumer drones
- 消防无人机
Firefighting drone
- 商用无人机
Commercial drone
- 工业无人机
Industrial drones
- 植保无人机
Plant protection drone



储能设备 Energy storage equipment

- 户外便携式电源
Outdoor portable power supply
- 家庭储能
Home energy storage
- 光伏储能
Photovoltaic energy storage
- 太阳能路灯
Solar street lamp
- 5G 基站
5G base station



智能家电 Smart home appliance

- 扫地机器人
Robotic vacuum cleaner
- 吸尘器
Vacuum cleaner
- 洗地机
Washing machine
- 筋膜枪
Fascia gun
- 紫外杀菌吸尘器
Ultraviolet sterilization vacuum cleaner



其他 other

- LED 灯
LED lamp
- 便携制氧机
Portable oxygen concentrator
- 产线传输线
Production line conveyor
- 3D 打印机
3D printer
- 化成分容
Chemical fractionati



产品系列 Product series	产品目录 Product catalog	页数 Pages	图片 Picture
LIFTF 标准系列 LIFTF Standard Series	LIFTF C20 系列 LIFTF C20 series	P10-13	 <p>*部分产品开发阶段 Partial Product Development Stage</p>
	LIFTF C30 系列 LIFTF C30 series	P14-17	
	LIFTF C40 系列 LIFTF C40 series	P18-20	
	LIFTF C50 系列 LIFTF C50 series	P21-22	
LIFTF 防水系列 LIFTF Upgrade Series	LIFTF F20 系列 LIFTF F20 series	P25-26	<p>LIFTF 防水系列是基于 LIFTF 标准系列衍生的防水升级版。全系继承强抗振、高稳定载流等核心优势，同时具备卓越的防水性能，从容应对潮湿、多尘等严苛内接环境。广泛适用于园林工具、电动工具等行业的内部连接场景。</p> <p>The LIFTF Waterproof Series is a waterproof upgraded version derived from the LIFTF standard series. The entire series inherits core advantages such as strong vibration resistance and high stable current carrying capacity, while also offering excellent waterproof performance, easily coping with harsh internal environments that are humid or dusty. It is widely applicable to internal connection scenarios in industries such as garden tools and power tools.</p> <p>*产品开发阶段 Product Development Stage</p>
	LIFTF F30 系列 LIFTF F30 series	P27-28	
	LIFTF F40 系列 LIFTF F40 series	P29-30	

LIFTF 复合系列 LIFTF Upgrade Series	LIFTF C20 复合系列 LIFTF C20 upgrade series	P33-37	<p>LIFTF复合系列是基于LIFTF标准系列衍生的电源-信号集成连接器。全系继承强抗振、高稳定载流等核心优势，同时复合集成信号传输，实现电源与信号的一体化连接。广泛适用于智能家电、智能机器人等行业的内部连接场景。</p> <p>The LIFTF composite series is a power-signal integrated connector derived from the LIFTF standard series. The entire series inherits core advantages such as strong vibration resistance and high stability in current carrying, while also integrating signal transmission, achieving unified connection for power and signals. It is widely used in internal connection scenarios in industries such as smart home appliances and intelligent robots.</p> <p>*产品开发阶段 Product Development Stage</p>
	LIFTF C30 复合系列 LIFTF C30 upgrade series	P38-42	
	LIFTF C40 复合系列 LIFTF C40 upgrade series	P43-47	
XL 紧凑系列 XL Compact Series	XL16 系列 XL16 series	P50-53	 <p>*部分产品开发阶段 Partial Product Development Stage</p>
	XL20 系列 XL20 series	P54-56	
	XL30 系列 XL16 series	P57-59	
	XL40 系列 XL20 series	P60-62	
<p>LIFTF 系列更多内接件产品 敬请期待!</p> <p>More internal components products of the LIFTF series are coming soon!</p>			

【产品说明 Description】

LIFTF 标准系列为通用型低压大电流连接器。全系采用车规级冠簧与按压式机械卡扣，接触件与塑壳为分离式装配。在确保强抗振、高稳定载流的同时，兼顾装配灵活性。广泛适用于代步工具、无人机、智能家电及智能机器人等行业的内部连接场景。

The LIFTF standard series is a general-purpose low-voltage, high-current connector. The entire series uses automotive-grade crown springs and push-type mechanical latches, with the contacts and plastic housing assembled separately. It ensures strong vibration resistance and high stable current carrying capacity, while also providing assembly flexibility. It is widely used for internal connection scenarios in industries such as mobility tools, drones, smart home appliances, and intelligent robots.

【型号命名 Type Designation】

LIFTF	C	10	1	PB	F
系列 series	品名 name of article	电极规格 Electrode specifications	PIN数 PIN number	结构 Structure	连接器公母端 Connector male and female
	C:标准款不防水 C:The standard model is not waterproof F:标准款防水 F:Standard Waterproof P:标准款防尘 P:Standard Dustproof	10: φ1mm 20: φ2mm 30: φ3mm 40: φ4mm	1: 1 PIN 2: 2 PIN 3: 3 PIN	不带:线式 Without: Linear P B:板立式 P B: Vertical board P W:板卧式 P W: Horizontal Plate	F:母端 F: Female M:公端 M: Male





【技术参数 Technical parameters】









额定电压 Rated voltage	150V DC	工作温度 Work temperature	-40~120°C	接触电阻 Contact resistance	≤0.6mΩ
绝缘电阻 Insulation resistance	≥2000MΩ	盐雾 Salt spray	48h	线式连接方式 Wire connection method	六方铆压 Hexagonal riveting
外壳材料 Housing material	PBT	端子材料 Terminal material	紫铜, 镀银 Copper, Silvering	板式连接方式 Plate connection method	焊接 Welding
阻燃等级 Materials flame level	UL94 V-0	灼热丝可燃性指数 Flammability index of heating wire	GWFI 850°C	环保性能 Environmental requirements	RoHS2.0、 Reach、PAHS、 TSCA、CP65

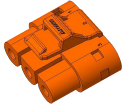
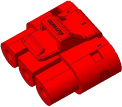

LIFTF C20 系列 LIFTF C20 Series

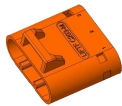
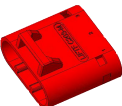
系列 Series	适配线规 Adapter gauge				额定电流 Current rating	温升 temperature rise
	美标 American Standard		国标 National Standard			
	A.W.G	铜丝 mm Copper wire	mm ²	铜丝 mm Copper wire		
LIFTF C20	16#	0.254	1.5	0.52	15A	30K
	18#		1.0	0.40	10A	
	16#		1.5	0.52	20A	55K
	18#		1.0	0.40	15A	
	16#		1.5	0.52	30A	85K
	18#		1.0	0.40	25A	

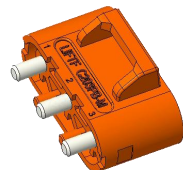
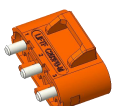
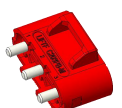
产品型号 Product model	产品名称 Product name	产品图 Product pictures	组件型号 Component Type	组件名称 Name of Component	组件图 Component diagram
LIFTF C202-F	LIFTF C202-F 成品 LIFTF C202-F finished product		/	LIFTF C202-F 橙色 LIFTF C202-F Orange	
			/	LIFTF C202-F 红色 LIFTF C202-F Red	
			/	LIFTF C202-F 黑色 LIFTF C202-F Black	
			/	LIFTF C20-F 铜件 LIFTF C20-F copper parts	

LIFTF C202-M	LIFTF C202-M 成品 LIFTF C202-M finished product		/	LIFTF C202-M 橙色 LIFTF C202-M Orange	
			/	LIFTF C202-M 红色 LIFTF C202-M Red	
			/	LIFTF C202-M 黑色 LIFTF C202-M Black	
			/	LIFTF C20-M 铜件 LIFTF C20-M copper parts	
LIFTF C202PB-M	LIFTF C202PB-M 成品 LIFTF C202PB-M finished product		/	LIFTF C202PB-M 橙色 LIFTF C202PB-M Orange	
			/	LIFTF C202PB-M 红色 LIFTF C202PB-M Red	
			/	LIFTF C202PB-M 黑色 LIFTF C202PB-M Black	
LIFTF C202PW-M	LIFTF C202PW-M 成品 LIFTF C202PW-M finished product		/	LIFTF C202PW-M 橙色 LIFTF C202PW-M Orange	
			/	LIFTF C202PW-M 红色 LIFTF C202PW-M Red	
			/	LIFTF C202PW-M 黑色 LIFTF C202PW-M Black	

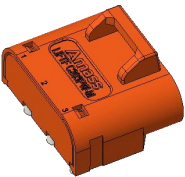
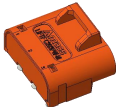
LIFTF C203-F	LIFTF C203-F 成品 LIFTF C203-F finished product		/	LIFTF C203-F 橙色 LIFTF C203-F Orange	
			/	LIFTF C203-F 红色 LIFTF C203-F Red	
			/	LIFTF C203-F 黑色 LIFTF C203-F Black	
			/	LIFTF C20-F 铜件 LIFTF C20-F copper parts	
LIFTF C203-M	LIFTF C203-M 成品 LIFTF C203-M finished product		/	LIFTF C203-M 橙色 LIFTF C203-M Orange	
			/	LIFTF C203-M 红色 LIFTF C203-M Red	
			/	LIFTF C203-M 黑色 LIFTF C203-M Black	
			/	LIFTF C20-M 铜件 LIFTF C20-M copper parts	
LIFTF C203PB-M	LIFTF C203PB-M 成品 LIFTF C203PB-M finished product		/	LIFTF C203PB-M 橙色 LIFTF C203PB-M Orange	
			/	LIFTF C203PB-M 红色 LIFTF C203PB-M Red	
			/	LIFTF C203PB-M 黑色 LIFTF C203PB-M Black	

LIFTF C203PW-M	LIFTF C203PW-M 成品 LIFTF C203PW-M finished product		/	LIFTF C203PW-M 橙色 LIFTF C203PW-M Orange	
			/	LIFTF C203PW-M 红色 LIFTF C203PW-M Red	
			/	LIFTF C203PW-M 黑色 LIFTF C203PW-M Black	

LIFTF C30 系列 LIFTF C30 Series

系列 Series	适配线规 Adapter gauge				额定电流 Current rating	温升 temperature rise
	美标 American Standard		国标 National Standard			
	A.W.G	铜丝 mm Copper wire	mm ²	铜丝 mm Copper wire		
LIFTF C302	12#	0.254	4.0	0.31	25A	30K
	14#		2.5	0.26	20A	
	12#		4.0	0.31	35A	55K
	14#		2.5	0.26	30A	
	12#		4.0	0.31	45A	85K
	14#		2.5	0.26	35A	
LIFTF C303	12#	0.254	4.0	0.31	25A	30K
	14#		2.5	0.26	20A	
	12#		4.0	0.31	35A	55K
	14#		2.5	0.26	25A	
	12#		4.0	0.31	45A	85K
	14#		2.5	0.26	35A	

		安装方式 installation method	LIFTF C302	LIFTF C303R
产品对插 外轮廓图 Product docking outline diagram	线-线 Line-Line		<p>公头 Male 母头 Female</p>	<p>公头 Male 母头 Female</p>
	线-板立 Line-Plate standing		<p>母头 Female 公头 Male</p>	
	线-板卧 Line-Plate lying		<p>母头 Female 公头 Male</p>	

产品型号 Product model	产品名称 Product name	产品图 Product pictures	组件型号 Component Type	组件名称 Name of Component	组件图 Component diagram
LIFTF C302 -F	LIFTF C302-F 成品 LIFTF C302-F finished product		97034-F.O	LIFTF C302-F 橙色 LIFTF C302-F Orange	
			97034-F.R	LIFTF C302-F 红色 LIFTF C302-F Red	
			97034-F.B	LIFTF C302-F 黑色 LIFTF C302-F Black	
			91028-F.S	LIFTF C30-F 铜件 LIFTF C30-F copper parts	

LIFTF C302-M	LIFTF C302-M 成品 LIFTF C302-M finished product		97034-M.O	LIFTF C302-M 橙色 LIFTF C302-M Orange	
			97034-M.R	LIFTF C302-M 红色 LIFTF C302-M Red	
			97034-M.B	LIFTF C302-M 黑色 LIFTF C302-M Black	
			99045-M.S	LIFTF C30-M 铜件 LIFTF C30-M copper parts	
LIFTF C302PB-M	LIFTF C302PB-M 成品 LIFTF C302PB-M finished product		LIFTF C302PB-M.S.O	LIFTF C302PB-M 橙色 LIFTF C302PB-M Orange	
			LIFTF C302PB-M.S.R	LIFTF C302PB-M 红色 LIFTF C302PB-M Red	
			LIFTF C302PB-M.S.B	LIFTF C302PB-M 黑色 LIFTF C302PB-M Black	
LIFTF C302PW-M	LIFTF C302PW-M 成品 LIFTF C302PW-M finished product		LIFTF C302PW-M.S.O	LIFTF C302PW-M 橙色 LIFTF C302PW-M Orange	
			LIFTF C302PW-M.S.R	LIFTF C302PW-M 红色 LIFTF C302PW-M Red	
			LIFTF C302PW-M.S.B	LIFTF C302PW-M 黑色 LIFTF C302PW-M Black	

LIFTF C303R-F	LIFTF C303R-F 成品 LIFTF C303R-F finished product		97038-F.O	LIFTF C303R-F 橙色 LIFTF C303R-F Orange	
			97038-F.R	LIFTF C303R-F 红色 LIFTF C303R-F Red	
			97038-F.B	LIFTF C303R-F 黑色 LIFTF C303R-F Black	
			91028-F.S	LIFTF C30-F 铜件 LIFTF C30-F copper parts	
LIFTF C303R-M	LIFTF C303R-M 成品 LIFTF C303R-M finished product		97038-M.O	LIFTF C303R-M 橙色 LIFTF C303R-M Orange	
			97038-M.R	LIFTF C303R-M 红色 LIFTF C303R-M Red	
			97038-M.B	LIFTF C303R-M 黑色 LIFTF C303R-M Black	
			99045-M.S	LIFTF C30-M 铜件 LIFTF C30-M copper parts	

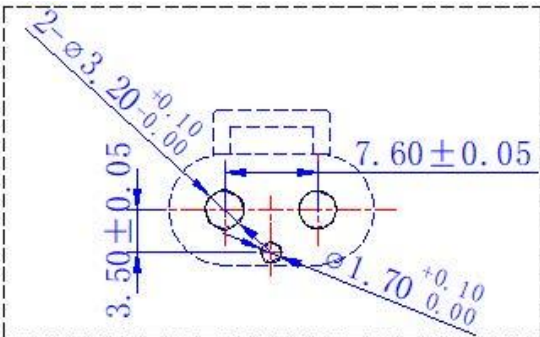
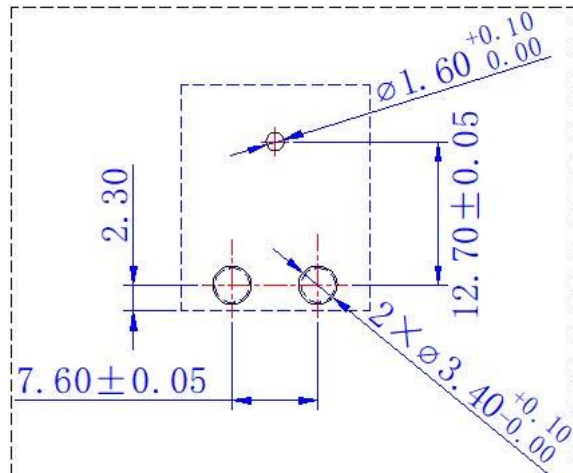



	LIFTF C302PB	LIFTF C302PW
PCB 开孔尺寸 PCB Cut-out size	 <p>Technical drawing showing PCB cut-out dimensions for LIFTF C302PB. Dimensions include: 2-$\phi 3.20^{+0.10}_{-0.00}$, 7.60 ± 0.05, 3.50 ± 0.05, $\phi 1.70^{+0.10}_{0.00}$.</p>	 <p>Technical drawing showing PCB cut-out dimensions for LIFTF C302PW. Dimensions include: $\phi 1.60^{+0.10}_{0.00}$, 2.30, 12.70 ± 0.05, 7.60 ± 0.05, $2 \times \phi 3.40^{+0.10}_{-0.00}$.</p>

LIFTF C40 系列 LIFTF C40 Series

系列 Series	适配线规 Adapter gauge				额定电流 Current rating	温升 temperature rise
	美标 American Standard		国标 National Standard			
	A.W.G	铜丝 mm Copper wire	mm ²	铜丝 mm Copper wire		
LIFTF C40	10#	0.254	6	0.31	35A	30K
	12#		4		30A	
	10#		6		45A	55K
	12#		4		40A	
	10#		6		60A	85K
	12#		4		50A	

产品对插 外轮廓图 Product docking outline diagram	安装方式 installation method	LIFTF C402
	线-线 Line-Line	
	线-板立 Line-Plate standing	
	线-板卧 Line-Plate lying	

产品型号 Product model	产品名称 Product name	产品图 Product pictures	组件型号 Component Type	组件名称 Name of Component	组件图 Component diagram
LIFTF C402-F	LIFTF C402-F 成品 LIFTF C402-F finished product		97037-F.O	LIFTF C402-F 橙色 LIFTF C402-F Orange	
			97037-F.R	LIFTF C402-F 红色 LIFTF C402-F Red	
			97037-F.B	LIFTF C402-F 黑色 LIFTF C402-F Black	
			91029-F.S	LIFTF C40-F 铜件 LIFTF C40-F copper parts	
LIFTF C402-M	LIFTF C402-M 成品 LIFTF C402-M finished product		97037-M.O	LIFTF C402-M 橙色 LIFTF C402-M Orange	
			97037-M.R	LIFTF C402-M 红色 LIFTF C402-M Red	
			97037-M.B	LIFTF C402-M 黑色 LIFTF C402-M Black	
			99044-M.S	LIFTF C40-M 铜件 LIFTF C40-M copper parts	
LIFTF C402 PB-M	LIFTF C402PB-M 成品 LIFTF C402PB-M finished product		LIFTF C402 PB-M.S.O	LIFTF C402PB-M 橙色 LIFTF C402PB-M Orange	
			LIFTF C402 PB-M.S.R	LIFTF C402PB-M 红色 LIFTF C402PB-M Red	
			LIFTF C402 PB-M.S.B	LIFTF C402PB-M 黑色 LIFTF C402PB-M Black	

LIFTF C402 PW-M	LIFTF C402PW -M 成品 LIFTF C402PW-M finished product		LIFTF C402 PW-M.S.O	LIFTF C402PW-M 橙色 LIFTF C402PW-M Orange	
			LIFTF C402 PW-M.S.R	LIFTF C402PW-M 红色 LIFTF C402PW-M Red	
			LIFTF C402 PW-M.S.B	LIFTF C402PW-M 黑色 LIFTF C402PW-M Black	

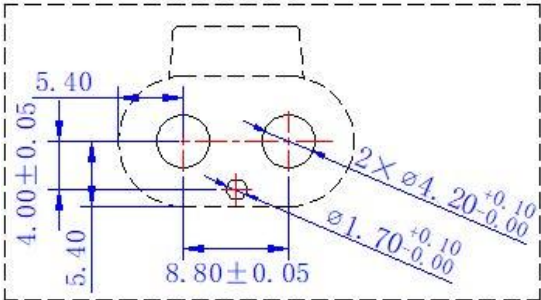
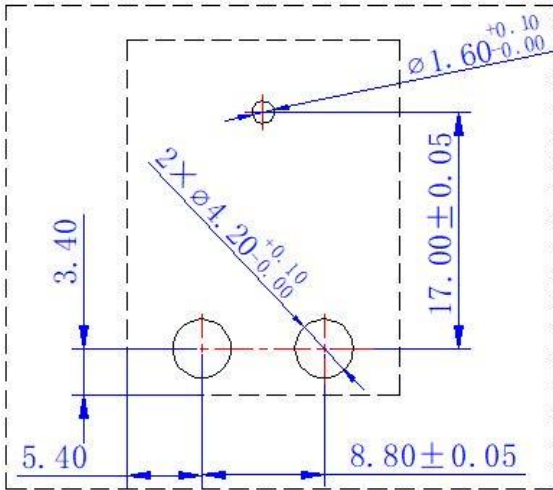
	LIFTF C402PB	LIFTF C402PW
PCB 开孔尺寸 PCB Cut-out size	 <p>Dimensions for LIFTF C402PB: 5.40 (width) 4.00 ± 0.05 (height) 5.40 (height) 8.80 ± 0.05 (width) $2 \times \phi 4.20^{+0.10}_{-0.00}$ (two circular holes) $\phi 1.70^{+0.10}_{-0.00}$ (central hole)</p>	 <p>Dimensions for LIFTF C402PW: 3.40 (height) 5.40 (width) 8.80 ± 0.05 (width) 17.00 ± 0.05 (height) $2 \times \phi 4.20^{+0.10}_{-0.00}$ (two circular holes) $\phi 1.60^{+0.10}_{-0.00}$ (central hole)</p>

LIFTF C50 系列 LIFTF C50 Series

系列 Series	适配线规 Adapter gauge				额定电流 Current rating	温升 temperature rise
	美标 American Standard		国标 National Standard			
	A.W.G	铜丝 mm Copper wire	mm ²	铜丝 mm Copper wire		
LIFTF C50	8#	0.254	10	0.31	55A	30K
	10#		6.0	0.26	35A	
	8#		10	0.31	70A	55K
	10#		6.0	0.26	45A	
	8#		10	0.31	90A	85K
	10#		6.0	0.26	55A	

	安装方式 installation method	LIFTF C503R
产品对插 外轮廓图 Product docking outline diagram	线-线 Line-Line	

产品型号 Product model	产品名称 Product name	产品图 Product pictures	组件型号 Component Type	组件名称 Name of Component	组件图 Component diagram
LIFTF C503R-F	LIFTF C503R-F 成品		/	LIFTF C503R-F 橙色 LIFTF C503R-F Orange	
	LIFTF C503R-F finished product		/	LIFTF C50-F 铜件 LIFTF C50-F copper parts	
LIFTF C503R-M	LIFTF C503R-M 成品		/	LIFTF C503R-M 黑色 LIFTF C503R-M Black	
	LIFTF C503R-M finished product		/	LIFTF C50-M 铜件 LIFTF C50-M copper parts	

【产品说明 Description】

LIFTF 防水系列是基于 LIFTF 标准系列衍生的防水升级版。全系继承强抗振、高稳定载流等核心优势，同时具备卓越的防水性能，从容应对潮湿、多尘等严苛内接环境。广泛适用于园林工具、电动工具等行业的内部连接场景。

The LIFTF waterproof series is a waterproof upgraded version derived from the LIFTF standard series. The entire series retains the core advantages of strong vibration resistance and high current-carrying stability, while also offering excellent waterproof performance, easily handling harsh internal connection environments such as humidity and dust. They are widely used in internal connection scenarios in industries such as garden tools and power tools.

【型号命名 Type Designation】

LIFTF 系列 series	C 品名 name of article	10 电极规格 Electrode specifications	1 PIN数 PIN number	PB 结构 Structure	F 连接器公母端 Connector male and female
	C:标准款不防水 C:The standard model is not waterproof F:标准款防水 F:Standard Waterproof P:标准款防尘 P:Standard Dustproof	10: φ1mm 20: φ2mm 30: φ3mm 40: φ4mm	1: 1 PIN 2: 2 PIN 3: 3 PIN	不带:线式 Without: Linear P B:板立式 P B: Vertical board P W:板卧式 P W: Horizontal Plate	F:母端 F: Female M:公端 M: Male





【技术参数 Technical parameters】

额定电压 Rated voltage	150V DC	工作温度 Work temperature	-40~120°C	接触电阻 Contact resistance	≤0.6mΩ
绝缘电阻 Insulation resistance	≥2000MΩ	盐雾 Salt spray	48h	线式连接方式 Wire connection method	六方铆压 Hexagonal riveting
外壳材料 Housing material	PBT	端子材料 Terminal material	紫铜, 镀银 Copper, Silvering	板式连接方式 Plate connection method	焊接 Welding
阻燃等级 Materials flame level	UL94 V-0	灼热丝可燃性指数 Flammability index of heating wire	GWFI 850°C	环保性能 Environmental requirements	RoHS2.0、 Reach、PAHS、 TSCA、CP65

LIFTF F20 系列 LIFTF F20 Series

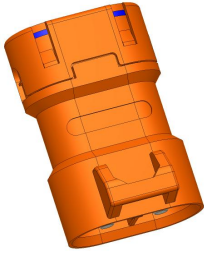
系列 Series	适配线规 Adapter gauge				额定电流 Current rating	温升 temperature rise
	美标 American Standard		国标 National Standard			
	A.W.G	铜丝 mm Copper wire	mm ²	铜丝 mm Copper wire		
LIFTF F20	16#	0.254	1.5	0.52	15A	30K
	18#		1.0	0.40	10A	
	16#		1.5	0.52	20A	55K
	18#		1.0	0.40	15A	
	16#		1.5	0.52	30A	85K
	18#		1.0	0.40	25A	



产品型号 Product model	产品名称 Product name	产品图 Product pictures	组件型号 Component Type	组件名称 Name of Component	组件图 Component diagram
LIFTF F202-F	LIFTF F202-F 成品 LIFTF F202-F finished product		/	LIFTF F202-F 橙色 LIFTF F202-F Orange	
			/	LIFTF F202-F 红色 LIFTF F202-F Red	
			/	LIFTF F202-F 黑色 LIFTF F202-F Black	
			/	LIFTF F20-F 铜件 LIFTF F20-F copper parts	

LIFTF F202-M	LIFTF F202-M 成品 LIFTF F202-M finished product		/	LIFTF F202-M 橙色 LIFTF F202-M Orange	
			/	LIFTF F202-M 红色 LIFTF F202-M Red	
			/	LIFTF F202-M 黑色 LIFTF F202-M Black	
			/	LIFTF F20-M 铜件 LIFTF F20-M copper parts	

LIFTF F30 系列 LIFTF F30 Series

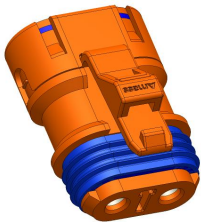
系列 Series	适配线规 Adapter gauge				额定电流 Current rating	温升 temperature rise
	美标 American Standard		国标 National Standard			
	A.W.G	铜丝 mm Copper wire	mm ²	铜丝 mm Copper wire		
LIFTF F30	12#	0.254	4	0.31	30A	30K
	14#		2.5	0.26	20A	
	12#		4	0.31	40A	55k
	14#		2.5	0.26	30A	
	12#		4	0.31	50A	85K
	14#		2.5	0.26	40A	

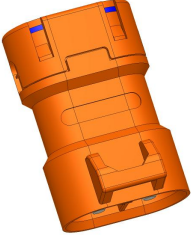
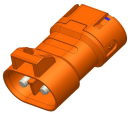
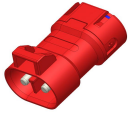

产品型号 Product model	产品名称 Product name	产品图 Product pictures	组件型号 Component Type	组件名称 Name of Component	组件图 Component diagram
LIFTF F302-F	LIFTF F302-F 成品 LIFTF F302-F finished product		/	LIFTF F302-F 橙色 LIFTF F302-F Orange	
			/	LIFTF F302-F 红色 LIFTF F302-F Red	
			/	LIFTF F302-F 黑色 LIFTF F302-F Black	
			/	LIFTF F30-F 铜件 LIFTF F30-F copper parts	

LIFTF F302-M	LIFTF F302-M 成品 LIFTF F302-M finished product		/	LIFTF F302-M 橙色 LIFTF F302-M Orange	
			/	LIFTF F302-M 红色 LIFTF F302-M Red	
			/	LIFTF F302-M 黑色 LIFTF F302-M Black	
			/	LIFTF F30-M 铜件 LIFTF F30-M copper parts	

LIFTF F40 系列 LIFTF F40 Series

系列 Series	适配线规 Adapter gauge				额定电流 Current rating	温升 temperature rise
	美标 American Standard		国标 National Standard			
	A.W.G	铜丝 mm Copper wire	mm ²	铜丝 mm Copper wire		
LIFTF F40	10#	0.254	6	0.31	35A	30K
	12#		4		30A	
	10#		6		45A	55K
	12#		4		40A	
	10#		6		60A	85K
	12#		4		50A	

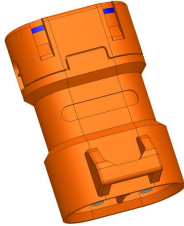
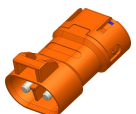
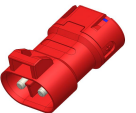
产品型号 Product model	产品名称 Product name	产品图 Product pictures	组件型号 Component Type	组件名称 Name of Component	组件图 Component diagram
LIFTF F402-F	LIFTF F402-F 成品 LIFTF F402-F finished product		/	LIFTF F402-F 橙色 LIFTF F402-F Orange	
			/	LIFTF F402-F 红色 LIFTF F402-F Red	
			/	LIFTF F402-F 黑色 LIFTF F402-F Black	
			/	LIFTF F40-F 铜件 LIFTF F40-F copper parts	

LIFTF F402-M	LIFTF F402-M 成品 LIFTF F402-M finished product		/	LIFTF F402-M 橙色 LIFTF F402-M Orange	
			/	LIFTF F402-M 红色 LIFTF F402-M Red	
			/	LIFTF F402-M 黑色 LIFTF F402-M Black	
			/	LIFTF F40-M 铜件 LIFTF F40-M copper parts	

【产品说明 Description】

LIFTF 复合系列是基于 LIFTF 标准系列衍生的电源-信号集成连接器。全系继承强抗振、高稳定载流等核心优势，同时复合集成信号传输，实现电源与信号的一体化连接。广泛适用于智能家电、智能机器人等行业的内部连接场景。

The LIFTF composite series is a power-signal integrated connector derived from the LIFTF standard series. The entire series inherits key advantages such as strong vibration resistance and high stable current carrying capacity, while also integrating signal transmission to achieve unified power and signal connection. It is widely applicable to internal connection scenarios in industries such as smart home appliances and intelligent robots.

【型号命名 Type Designation】

LIFTF	C	10	1	+1	B	F	.1
系列 Series	品名 name of article	电极规格 Electrode specifications	PIN数 PIN number	信号数 Number of signals	结构 Structure	连接器公母端 Connector male and female	版本号 Version number
	C:标准款不防水 C:The standard model is not waterproof F:标准款防水 F:Standard Waterproof P:标准款防尘 P:Standard Dustproof	10: φ1mm 20: φ2mm 30: φ3mm 40: φ4mm	1: 1 PIN 2: 2 PIN 3: 3 PIN	空: 不带信号 Empty: No signal +1: 带1PIN信号 +1: With 1-pin signal +2: 带2PIN信号 +2: With 2-pin signal +4: 带4PIN信号 +4: With 4-pin signal +6: 带6PIN信号 +6: With 6-pin signal	空置: 甩线 Idle: Dropped line P B: 板立式 P B: Vertical board P W: 板卧式 P W: Horizontal Plate D: 包胶 D: Coating R: 三角形 R: Triangle	F: 母端 F: Female M: 公端 M: Male	









【技术参数 Technical parameters】

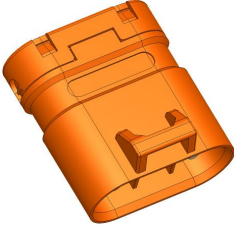
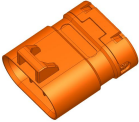
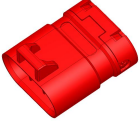



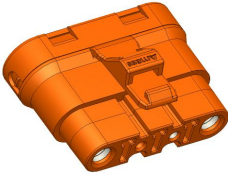
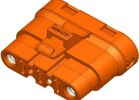
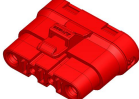

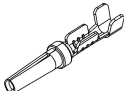



额定电压 Rated voltage	150V DC	工作温度 Work temperature	-40~120°C	接触电阻 Contact resistance	≤0.6mΩ
绝缘电阻 Insulation resistance	≥2000MΩ	盐雾 Salt spray	48h	线式连接方式 Wire connection method	六方铆压 Hexagonal riveting
外壳材料 Housing material	PBT	端子材料 Terminal material	紫铜, 镀银 Copper, Silvering	板式连接方式 Plate connection method	焊接 Welding
阻燃等级 Materials flame level	UL94 V-0	灼热丝可燃性指数 Flammability index of heating wire	GWFI 850°C	环保性能 Environmental requirements	RoHS2.0、 Reach、PAHS、 TSCA、CP65

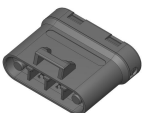

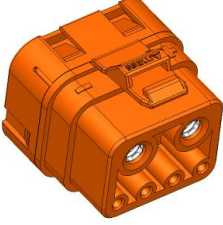



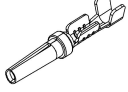



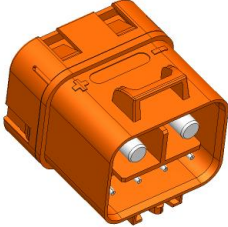

LIFTF C20 复合系列 LIFTF C20 Composite Series



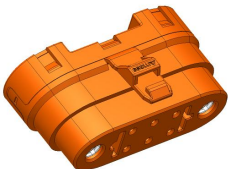

系列 Series	适配线规 Adapter gauge				额定电流 Current rating	温升 temperature rise
	美标 American Standard		国标 National Standard			
	A.W.G	铜丝 mm Copper wire	mm ²	铜丝 mm Copper wire		
LIFTF 20 复合系列	14#	0.254	2.5	0.26	20A	30K
	16#		1.5	0.20	15A	
	14#		2.5	0.26	30A	55K
	16#		1.5	0.20	20A	
	14#		2.5	0.26	40A	85K
	16#		1.5	0.20	30A	

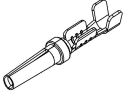
产品型号 Product model	产品名称 Product name	产品图 Product pictures	组件型号 Component Type	组件名称 Name of Component	组件图 Component diagram
LIFTF C202+1-F	LIFTF C202+1-F 成品 LIFTF C202+1-F finished product		/	LIFTF C202+1-F 橙色 LIFTF C202+1-F Orange	
			/	LIFTF C202+1-F 红色 LIFTF C202+1-F Red	
			/	LIFTF C202+1-F 黑色 LIFTF C202+1-F Black	
			/	LQ2001-F 信号针 LQ2001-F signal pin	
			/	LIFTF C202+1-F 铜件 LIFTF C202+1-F copper parts	

LIFTF C202+1-M	LIFTF C202+1-M 成品 LIFTF C202+1-M finished product		/	LIFTF C202+1-M 橙色 LIFTF C202+1-M Orange	
			/	LIFTF C202+1-M 红色 LIFTF C202+1-M Red	
			/	LIFTF C202+1-M 黑色 LIFTF C202+1-M Black	
			/	LQ2001-M 信号针 LQ2001-M signal pin	
			/	LIFTF C202+1-M 铜件 LIFTF C202+1-M copper parts	
LIFTF C202+2-F	LIFTF C202+2-F 成品 LIFTF C202+2-F finished product		/	LIFTF C202+2-F 橙色 LIFTF C202+2-F Orange	
			/	LIFTF C202+2-F 红色 LIFTF C202+2-F Red	
			/	LIFTF C202+2-F 黑色 LIFTF C202+2-F Black	
			/	LQ2001-F 信号针 LQ2001-F signal pin	
			/	LIFTF C202+2-F 铜件 LIFTF C202+2-F copper parts	

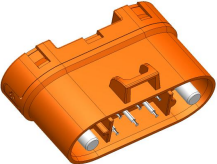
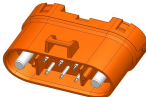





LIFTF C202+2-M	LIFTF C202+2-M 成品 LIFTF C202+2-M finished product		/	LIFTF C202+2-M 橙色 LIFTF C202+2-M Orange	
			/	LIFTF C202+2-M 红色 LIFTF C202+2-M Red	
			/	LIFTF C202+2-M 黑色 LIFTF C202+2-M Black	
			/	LQ2001-M 信号针 LQ2001-M signal pin	
			/	LIFTF C202+2-M 铜件 LIFTF C202+2-M copper parts	
LIFTF C202+4-F	LIFTF C202+4-F 成品 LIFTF C202+4-F finished product		/	LIFTF C202+4-F 橙色 LIFTF C202+4-F Orange	
			/	LIFTF C202+4-F 红色 LIFTF C202+4-F Red	
			/	LIFTF C202+4-F 黑色 LIFTF C202+4-F Black	
			/	LQ2001-F 信号针 LQ2001-F signal pin	
			/	LIFTF C202+4-F 铜件 LIFTF C202+4-F copper parts	







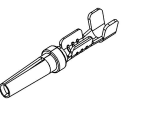

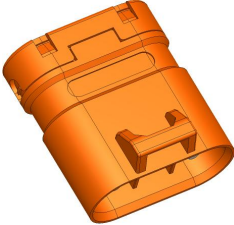
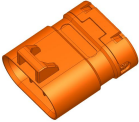
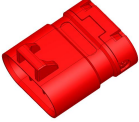

LIFTF C202+4-M	LIFTF C202+4-M 成品 LIFTF C202+4-M finished product		/	LIFTF C202+4-M 橙色 LIFTF C202+4-M Orange	
			/	LIFTF C202+4-M 红色 LIFTF C202+4-M Red	
			/	LIFTF C202+4-M 黑色 LIFTF C202+4-M Black	
			/	LQ2001-M 信号针 LQ2001-M signal pin	
			/	LIFTF C202+4-M 铜件 LIFTF C202+4-M copper parts	
LIFTF C202+6-F	LIFTF C202+6-F 成品 LIFTF C202+6-F finished product		/	LIFTF C202+6-F 橙色 LIFTF C202+6-F Orange	
			/	LIFTF C202+6-F 红色 LIFTF C202+6-F Red	
			/	LIFTF C202+6-F 黑色 LIFTF C202+6-F Black	
			/	LQ2001-F 信号针 LQ2001-F signal pin	
			/	LIFTF C202+6-F 铜件 LIFTF C202+6-F copper parts	



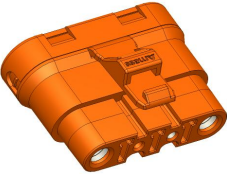

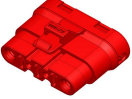

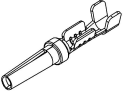



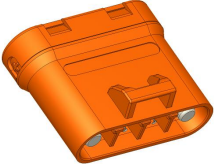

LIFTF C202+6-M	LIFTF C202+6-M 成品 LIFTF C202+6-M finished product		/	LIFTF C202+6-M 橙色 LIFTF C202+6-M Orange	
			/	LIFTF C202+6-M 红色 LIFTF C202+6-M Red	
			/	LIFTF C202+6-M 黑色 LIFTF C202+6-M Black	
			/	LQ2001-M 信号针 LQ2001-M signal pin	
			/	LIFTF C202+6-M 铜件 LIFTF C202+6-M copper parts	



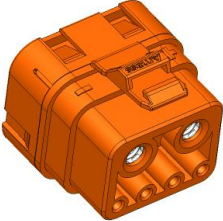



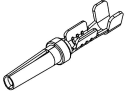



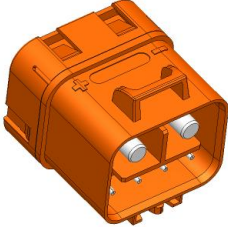

LIFTF C30 复合系列 LIFTF C30 Composite Series



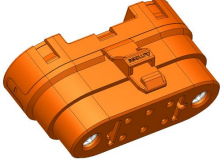

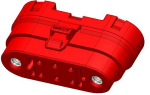
系列 Series	适配线规 Adapter gauge				额定电流 Current rating	温升 temperature rise
	美标 American Standard		国标 National Standard			
	A.W.G	铜丝 mm Copper wire	mm ²	铜丝 mm Copper wire		
LIFTF C30 复合系列	12#	0.254	4.0	0.31	30A	30K
	14#		2.5	0.26	20A	
	12#		4.0	0.31	40A	55K
	14#		2.5	0.26	30A	
	12#		4.0	0.31	50A	85K
	14#		2.5	0.26	40A	

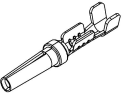
产品型号 Product model	产品名称 Product name	产品图 Product pictures	组件型号 Component Type	组件名称 Name of Component	组件图 Component diagram
LIFTF C302+1-F	LIFTF C302+1-F 成品 LIFTF C302+1-F finished product		/	LIFTF C302+1-F 橙色 LIFTF C302+1-F Orange	
			/	LIFTF C302+1-F 红色 LIFTF C302+1-F Red	
			/	LIFTF C302+1-F 黑色 LIFTF C302+1-F Black	
			/	LQ2001-F 信号针 LQ2001-F signal pin	
			/	LIFTF C302+1-F 铜件 LIFTF C302+1-F copper parts	

LIFTF C302+1-M	LIFTF C302+1-M 成品 LIFTF C302+1-M finished product		/	LIFTF C302+1-M 橙色 LIFTF C302+1-M Orange	
			/	LIFTF C302+1-M 红色 LIFTF C302+1-M Red	
			/	LIFTF C302+1-M 黑色 LIFTF C302+1-M Black	
			/	LQ2001-M 信号针 LQ2001-M signal pin	
			/	LIFTF C302+1-M 铜件 LIFTF C302+1-M copper parts	
LIFTF C302+2-F	LIFTF C302+2-F 成品 LIFTF C302+2-F finished product		/	LIFTF C302+2-F 橙色 LIFTF C302+2-F Orange	
			/	LIFTF C302+2-F 红色 LIFTF C302+2-F Red	
			/	LIFTF C302+2-F 黑色 LIFTF C302+2-F Black	
			/	LQ2001-F 信号针 LQ2001-F signal pin	
			/	LIFTF C302+2-F 铜件 LIFTF C302+2-F copper parts	

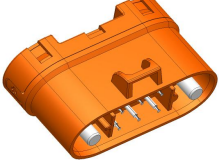
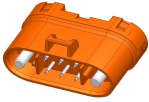





LIFTF C302+2-M	LIFTF C302+2-M 成品 LIFTF C302+2-M finished product		/	LIFTF C302+2-M 橙色 LIFTF C302+2-M Orange	
			/	LIFTF C302+2-M 红色 LIFTF C302+2-M Red	
			/	LIFTF C302+2-M 黑色 LIFTF C302+2-M Black	
			/	LQ2001-M 信号针 LQ2001-M signal pin	
			/	LIFTF C302+2-M 铜件 LIFTF C302+2-M copper parts	
LIFTF C302+4-F	LIFTF C302+4-F 成品 LIFTF C302+4-F finished product		/	LIFTF C302+4-F 橙色 LIFTF C302+4-F Orange	
			/	LIFTF C302+4-F 红色 LIFTF C302+4-F Red	
			/	LIFTF C302+4-F 黑色 LIFTF C302+4-F Black	
			/	LQ2001-F 信号针 LQ2001-F signal pin	
			/	LIFTF C302+4-F 铜件 LIFTF C302+4-F copper parts	





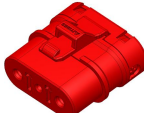

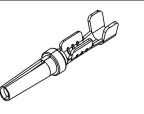

LIFTF C302+4-M	LIFTF C302+4-M 成品 LIFTF C302+4-M finished product		/	LIFTF C302+4-M 橙色 LIFTF C302+4-M Orange	
			/	LIFTF C302+4-M 红色 LIFTF C302+4-M Red	
			/	LIFTF C302+4-M 黑色 LIFTF C302+4-M Black	
			/	LQ2001-M 信号针 LQ2001-M signal pin	
			/	LIFTF C302+4-M 铜件 LIFTF C302+4-M copper parts	
LIFTF C302+6-F	LIFTF C302+6-F 成品 LIFTF C302+6-F finished product		/	LIFTF C302+6-F 橙色 LIFTF C302+6-F Orange	
			/	LIFTF C302+6-F 红色 LIFTF C302+6-F Red	
			/	LIFTF C302+6-F 黑色 LIFTF C302+6-F Black	
			/	LQ2001-F 信号针 LQ2001-F signal pin	
			/	LIFTF C302+6-F 铜件 LIFTF C302+6-F copper parts	

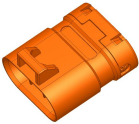
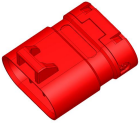



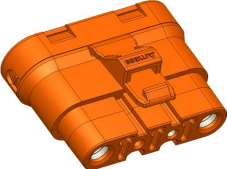
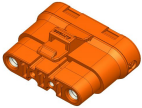

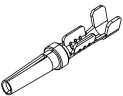





LIFTF C302+6-M	LIFTF C302+6-M 成品 LIFTF C302+6-M finished product		/	LIFTF C302+6-M 橙色 LIFTF C302+6-M Orange	
			/	LIFTF C302+6-M 红色 LIFTF C302+6-M Red	
			/	LIFTF C302+6-M 黑色 LIFTF C302+6-M Black	
			/	LQ2001-M 信号针 LQ2001-M signal pin	
			/	LIFTF C302+6-M 铜件 LIFTF C302+6-M copper parts	



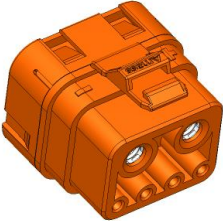



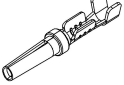



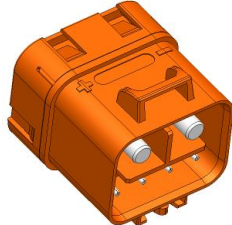

LIFTF C40 复合系列 LIFTF C40 Composite Series

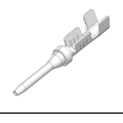

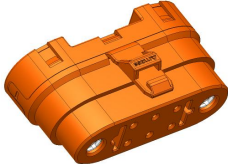

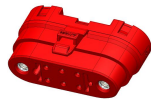
系列 Series	适配线规 Adapter gauge				额定电流 Current rating	温升 temperature rise
	美标 American Standard		国标 National Standard			
	A.W.G	铜丝 mm Copper wire	mm ²	铜丝 mm Copper wire		
LIFTF 40 复合系列	10#	0.254	6	0.31	35A	30K
	12#		4		30A	
	10#		6		45A	55K
	12#		4		40A	
	10#		6		60A	85K
	12#		4		50A	

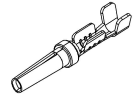
产品型号 Product model	产品名称 Product name	产品图 Product pictures	组件型号 Component Type	组件名称 Name of Component	组件图 Component diagram
LIFTF C402+1-F	LIFTF C402+1-F 成品 LIFTF C402+1-F finished product		/	LIFTF C402+1-F 橙色 LIFTF C402+1-F Orange	
			/	LIFTF C402+1-F 红色 LIFTF C402+1-F Red	
			/	LIFTF C402+1-F 黑色 LIFTF C402+1-F Black	
			/	LQ2001-F 信号针 LQ2001-F signal pin	
			/	LIFTF C402+1-F 铜件 LIFTF C402+1-F copper parts	

LIFTF C402+1-M	LIFTF C402+1-M 成品 LIFTF C402+1-M finished product		/	LIFTF C402+1-M 橙色 LIFTF C402+1-M Orange	
			/	LIFTF C402+1-M 红色 LIFTF C402+1-M Red	
			/	LIFTF C402+1-M 黑色 LIFTF C402+1-M Black	
			/	LQ2001-M 信号针 LQ2001-M signal pin	
			/	LIFTF C402+1-M 铜件 LIFTF C402+1-M copper parts	
LIFTF C402+2-F	LIFTF C402+2-F 成品 LIFTF C402+2-F finished product		/	LIFTF C402+2-F 橙色 LIFTF C402+2-F Orange	
			/	LIFTF C402+2-F 红色 LIFTF C402+2-F Red	
			/	LIFTF C402+2-F 黑色 LIFTF C402+2-F Black	
			/	LQ2001-F 信号针 LQ2001-F signal pin	
			/	LIFTF C402+2-F 铜件 LIFTF C402+2-F copper parts	

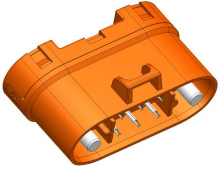
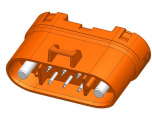
LIFTF C402+2-M	LIFTF C402+2-M 成品 LIFTF C402+2-M finished product		/	LIFTF C402+2-M 橙色 LIFTF C402+2-M Orange	
			/	LIFTF C402+2-M 红色 LIFTF C402+2-M Red	
			/	LIFTF C402+2-M 黑色 LIFTF C402+2-M Black	
			/	LQ2001-M 信号针 LQ2001-M signal pin	
			/	LIFTF C402+2-M 铜件 LIFTF C402+2-M copper parts	
LIFTF C402+4-F	LIFTF C402+4-F 成品 LIFTF C402+4-F finished product		/	LIFTF C402+4-F 橙色 LIFTF C402+4-F Orange	
			/	LIFTF C402+4-F 红色 LIFTF C402+4-F Red	
			/	LIFTF C402+4-F 黑色 LIFTF C402+4-F Black	
			/	LQ2001-F 信号针 LQ2001-F signal pin	
			/	LIFTF C402+4-F 铜件 LIFTF C402+4-F copper parts	

LIFTF C402+4-M	LIFTF C402+4-M 成品 LIFTF C402+4-M finished product		/	LIFTF C402+4-M 橙色 LIFTF C402+4-M Orange	
			/	LIFTF C402+4-M 红色 LIFTF C402+4-M Red	
			/	LIFTF C402+4-M 黑色 LIFTF C402+4-M Black	
			/	LQ2001-M 信号针 LQ2001-M signal pin	
			/	LIFTF C402+4-M 铜件 LIFTF C402+4-M copper parts	
LIFTF C402+6-F	LIFTF C402+6-F 成品 LIFTF C402+6-F finished product		/	LIFTF C402+6-F 橙色 LIFTF C402+6-F Orange	
			/	LIFTF C402+6-F 红色 LIFTF C402+6-F Red	
			/	LIFTF C402+6-F 黑色 LIFTF C402+6-F Black	
			/	LQ2001-F 信号针 LQ2001-F signal pin	
			/	LIFTF C402+6-F 铜件 LIFTF C402+6-F copper parts	

LIFTF C402+6-M	LIFTF C402+6-M 成品 LIFTF C402+6-M finished product		/	LIFTF C402+6-M 橙色 LIFTF C402+6-M Orange	
			/	LIFTF C402+6-M 红色 LIFTF C402+6-M Red	
			/	LIFTF C402+6-M 黑色 LIFTF C402+6-M Black	
			/	LQ2001-M 信号针 LQ2001-M signal pin	
			/	LIFTF C402+6-M 铜件 LIFTF C402+6-M copper parts	

【产品说明 Description】

XL 紧凑系列专为极限空间场景打造的低压大电流连接器。全系采用车规级冠簧接触件与按压式机械卡扣，接触件与塑壳一体化集成。在实现强抗振、高稳定载流的同时，大幅压缩安装体积。适用于对整机空间极度敏感的环节，典型应用包括锂电池与控制器、电机与控制器之间的紧凑连接。

The XL Compact series is a low-voltage, high-current connector specifically designed for extreme space applications. The entire series uses automotive-grade crown spring contacts and press-type mechanical latches, with the contacts integrated with the plastic housing. While providing strong vibration resistance and high stable current carrying capacity, it significantly reduces installation volume. It is suitable for components that are extremely space-sensitive, with typical applications including compact connections between lithium batteries and controllers, and between motors and controllers.

【型号命名 Type Designation】

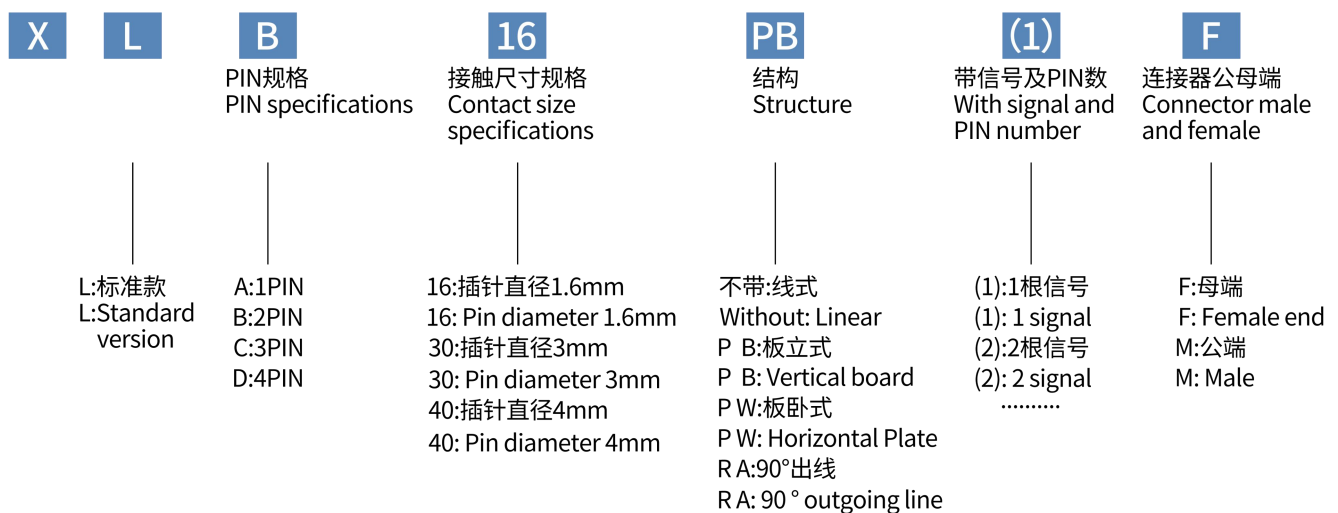

【技术参数 Technical parameters】

额定电压 Rated voltage	80V DC	工作温度 Work temperature	-40~120°C	接触电阻 Contact resistance	≤1.2mΩ
绝缘电阻 Insulation resistance	≥2000MΩ	盐雾 Salt spray	48h	线式连接方式 Wire connection method	B 型铆压 Type B riveting XLB20 线式包含焊接 XLB20 line type includes welding
外壳材料 Housing material	PBT	端子材料 Terminal material	紫铜, 镀银 Copper, Silvering	板式连接方式 Plate connection method	焊接 Welding
阻燃等级 Materials flame level	UL94 V-0 (0.8mm)	灼热丝可燃性指数 Flammability index of heating wire	GWFI 850°C (0.8mm)	环保性能 Environmental requirements	RoHS2.0、Reach、PAHS、TSCA、CP65

XL16 系列 XL16 series









系列 Series	适配线径 Adaptive wire diameter	额定电流 Rated current	温升 Temperature rise
	A.W.G		
XL16	16#	16A	55K
	18#	12A	
	16#	22A	85K
	18#	15A	

安装方式 Installation method		XLB16	XLC16
产品对插 外轮廓图 Product docking outline diagram	线-线 Line-Line	<p>母头 Female 公头 Male</p>	<p>母头 Female 公头 Male</p>
	线-板立 Line-Plate standing	<p>母头 Female 公头 Male</p>	<p>母头 Female 公头 Male</p>
	线-板卧 Line-Board Lie	<p>母头 Female 公头 Male</p>	<p>母头 Female 公头 Male</p>

低压大电流动力连接 Low-voltage high-current power connection

产品型号 Product model	产品名称 Product name	产品图 Product pictures	组件型号 Component Type	组件名称 Name of Component	组件图 Component diagram
XLB16-F	XLB16-F 成品 XLB16-F finished product		XLB16-F.S.Y	XLB16-F 黄色 XLB16-F Yellow	
			XLB16-F.S.R	XLB16-F 红色 XLB16-F Red	
			XLB16-F.S.B	XLB16-F 黑色 XLB16-F Black	
			98036.PG	XLB16 后盖 XLB16 Back cover	
XLB16-M	XLB16-M 成品 XLB16-M finished product		XLB16-M.S.Y	XLB16-M 黄色 XLB16-M Yellow	
			XLB16-M.S.R	XLB16-M 红色 XLB16-M Red	
			XLB16-M.S.B	XLB16-M 黑色 XLB16-M Black	
			98036.PG	XLB16 后盖 XLB16 Back cover	
XLB16PB-M	XLB16PB-M 成品 XLB16PB-M finished product		XLB16PB-M.S.Y	XLB16PB-M 黄色 XLB16PB-M Yellow	
			XLB16PB-M.S.R	XLB16PB-M 红色 XLB16PB-M Red	
			XLB16PB-M.S.B	XLB16PB-M 黑色 XLB16PB-M Black	

XLB16PW-M	XLB16PW-M 成品 XLB16PW-M finished product		XLB16PW-M.S.Y	XLB16PW-M 黄色 XLB16PW-M Yellow	
			XLB16PW-M.S.R	XLB16PW-M 红色 XLB16PW-M Red	
			XLB16PW-M.S.B	XLB16PW-M 黑色 XLB16PW-M Black	
XLC16-F	XLC16-F 成品 XLC16-F finished product		XLC16-F.S.Y	XLC16-F 黄色 XLC16-F Yellow	
			XLC16-F.S.R	XLC16-F 红色 XLC16-F Red	
			XLC16-F.S.B	XLC16-F 黑色 XLC16-F Black	
			98037.PG	XLC16 后盖 XLC16 Back cover	
XLC16-M	XLC16-M 成品 XLC16-M finished product		XLC16-M.S.Y	XLC16-M 黄色 XLC16-M Yellow	
			XLC16-M.S.R	XLC16-M 红色 XLC16-M Red	
			XLC16-M.S.B	XLC16-M 黑色 XLC16-M Black	
			98037.PG	XLC16 后盖 XLC16 Back cover	

XLC16PB-M	XLC16PB-M 成品 XLC16PB-M finished product		XLC16PB-M .S.Y	XLC16PB-M 黄色 XLC16PB-M Yellow	
			XLC16PB-M .S.R	XLC16PB-M 红色 XLC16PB-M Red	
			XLC16PB-M .S.B	XLC16PB-M 黑色 XLC16PB-M Black	
XLC16PW-M	XLC16PW-M 成品 XLC16PW-M finished product		XLC16PW-M .S.Y	XLC16PW-M 黄色 XLC16PW-M Yellow	
			XLC16PW-M .S.R	XLC16PW-M 红色 XLC16PW-M Red	
			XLC16PW-M .S.B	XLC16PW-M 黑色 XLC16PW-M Black	

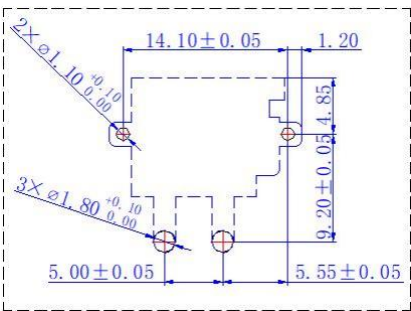
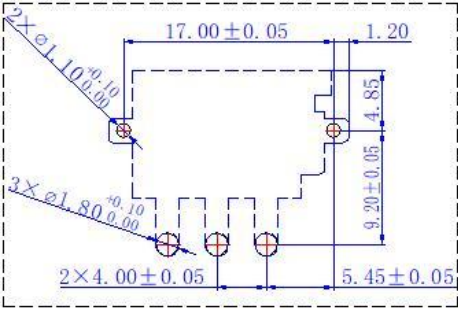
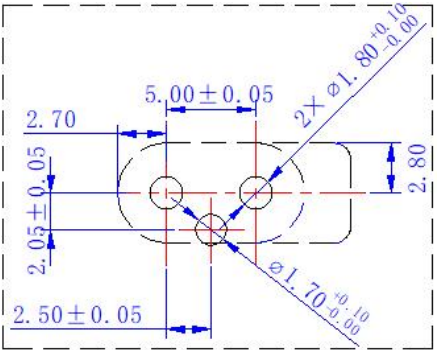
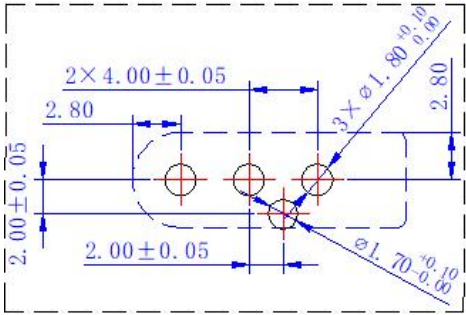
	XLB16	XLC16
PCB 开孔尺寸 PCB Cut-out size	<p>XLB16PW-M PCB LAYOUT</p> 	<p>XLC16PW-M PCB LAYOUT</p> 
	<p>XLB16PB-M PCB LAYOUT</p> 	<p>XLC16PB-M PCB LAYOUT</p> 

XL20 系列 XL20 series

系列 Series	适配线径 Adaptive wire diameter	额定电流 Rated current	温升 Temperature rise
	A.W.G		
XL20	12#	15A	30K
	14#	10A	
	12#	25A	55k
	14#	20A	
	12#	30A	85K
	14#	25A	

	安装方式 installation method	XLB20
产品对插 外轮廓图 Product docking outline diagram	线-线 Line-Line	<p>母头 Female 公头 Male</p>
	线-板立 Line-Plate standing	<p>母头 Female 公头 Male</p>
	线-板卧 Line-Board Lie	<p>母头 Female 公头 Male</p>

低压大电流动力连接 Low-voltage high-current power connection

产品型号 Product model	产品名称 Product name	产品图 Product pictures	组件型号 Component Type	组件名称 Name of Component	组件图 Component diagram
XLB20 (2) -F	XLB20 (2) -F 成品 XLB20 (2) -F finished product		XLB20 (2) -F.S.Y	XLB20 (2) -F 黄色 XLB20(2)-F Yellow	
			XLB20 (2) -F.S.R	XLB20 (2) -F 红色 XLB20(2)-F Red	
			XLB20 (2) -F.S.B	XLB20 (2) -F 黑色 XLB20(2)-F Black	
XLB20 (2) -M	XLB20 (2) -M 成品 XLB20 (2) -M finished product		XLB20 (2) -M.S.Y	XLB20 (2) -M 黄色 XLB20(2)-M Yellow	
			XLB20 (2) -M.S.R	XLB20 (2) -M 红色 XLB20(2)-M Red	
			XLB20 (2) -M.S.B	XLB20 (2) -M 黑色 XLB20(2)-M Black	
XLB20 (2) PW-M	XLB20PW (2) -M 成品 XLB20PW (2) -M finished product		XLB20PW (2) -M.S.Y	XLB20PW (2) -M 黄色 XLB20PW(2)-M Yellow	
			XLB20PW (2) -M.S.R	XLB20PW (2) -M 红色 XLB20PW(2)-M Red	
			XLB20PW (2) -M.S.B	XLB20PW (2) -M 黑色 XLB20PW(2)-M Black	

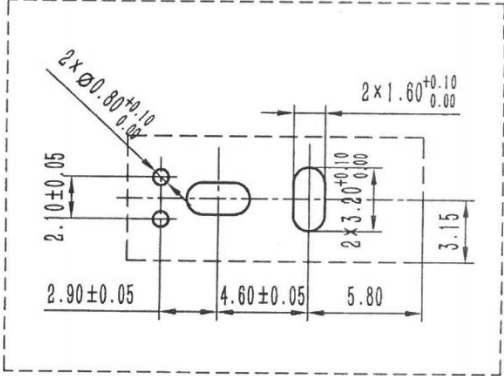
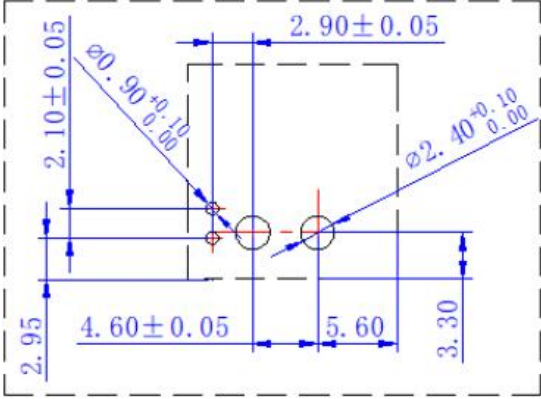
	XLB20 (2) -M	XLB20PW (2) -M
<p>PCB 开孔尺寸</p> <p>PCB Cut-out size</p>	<p>PCB LAYOUT</p> 	<p>PCB LAYOUT</p> 

XL30 系列 XL30 series

系列 Series	适配线径 Adaptive wire diameter	额定电流 Rated current	温升 Temperature rise
	A.W.G		
XL30	12#	30A	55K
	14#	25A	
	12#	40A	85K
	14#	30A	

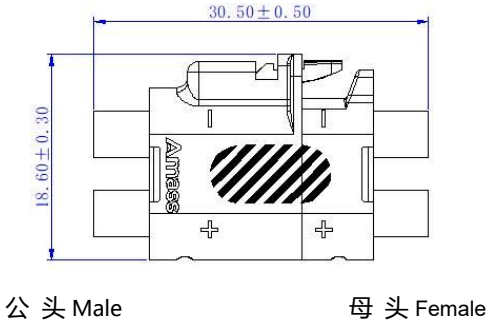
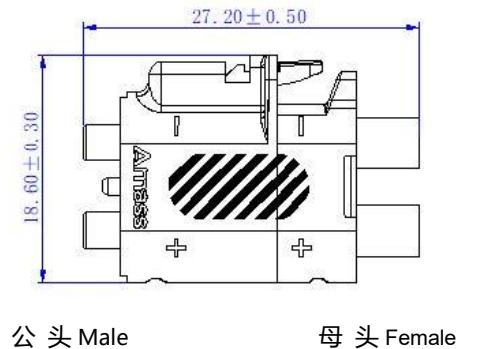
安装方式 installation method		XLB30
产品对插 外轮廓图 Product docking outline diagram	线-线 Line-Line	 <p>公头 Male 母头 Female</p>
	线-板立 Line-Plate standing	 <p>公头 Male 母头 Female</p>

产品型号 Product model	产品名称 Product name	产品图 Product pictures	组件型号 Component Type	组件名称 Name of Component	组件图 Component diagram
XLB30-F	XLB30-F 成品 XLB30-F finished product		XLB30-F.S.Y	XLB30-F 黄色 XLB30-F Yellow	
			XLB30-F.S.R	XLB30-F 红色 XLB30-F Red	
			XLB30-F.S.B	XLB30-F 黑色 XLB30-F Black	
			98034.PG	XLB30 后盖 XLB30 Back cover	
XLB30-M	XLB30-M 成品 XLB30-M finished product		XLB30-M.S.Y	XLB30-M 黄色 XLB30-M Yellow	
			XLB30-M.S.R	XLB30-M 红色 XLB30-M Red	
			XLB30-M.S.B	XLB30-M 黑色 XLB30-M Black	
			98034.PG	XLB30 后盖 XLB30 Back cover	
XLB30PB-M	XLB30PB-M 成品 XLB30PB-M		XLB30PB-M .S.Y	XLB30PB-M 黄色 XLB30PB-M Yellow	
			XLB30PB-M .S.R	XLB30PB-M 红色 XLB30PB-M Red	
			XLB30PB-M .S.B	XLB30PB-M 黑色 XLB30PB-M Black	

XLB30PB-M

PCB LAYOUT

PCB
开孔尺寸
PCB
Cut-out size

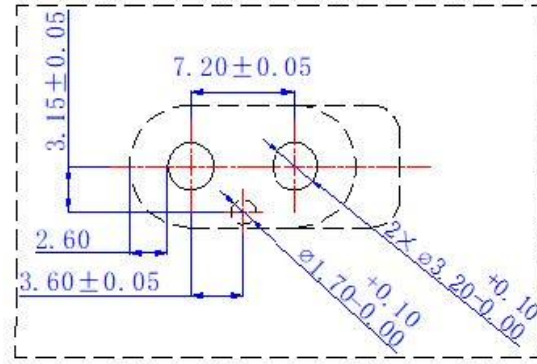

XL40 系列 XL40 series

系列 Series	适配线径 Adaptive wire diameter	额定电流 Rated current	温升 Temperature rise
	A.W.G		
XL40	10#	40A	55K
	12#	35A	
	10#	50A	85K
	12#	45A	

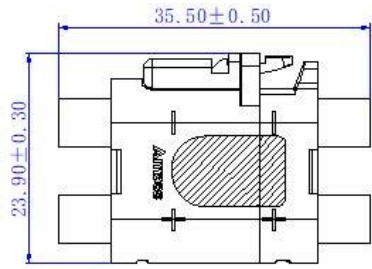
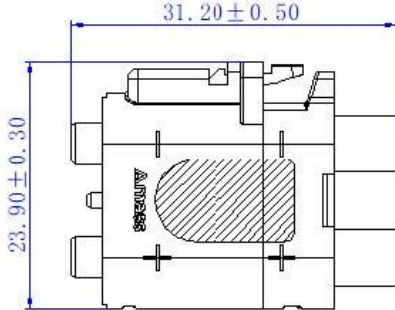
安装方式 installation method		XLB40
产品对插 外轮廓图 Product docking outline diagram	线-线 Line-Line	 <p>公头 Male 母头 Female</p>
	线-板立 Line-Plate standing	 <p>公头 Male 母头 Female</p>

产品型号 Product model	产品名称 Product name	产品图 Product pictures	组件型号 Component Type	组件名称 Name of Component	组件图 Component diagram
XLB40-F	XLB40-F 成品 XLB40-F finished product		XLB40-F.S.Y	XLB40-F 黄色 XLB40-F Yellow	
			XLB40-F.S.R	XLB40-F 红色 XLB40-F Red	
			XLB40-F.S.B	XLB40-F 黑色 XLB40-F Black	
			98034.PG	XLB40 后盖 XLB40 Back cover	
XLB40-M	XLB40-M 成品 XLB40-M finished product		XLB40-M.S.Y	XLB40-M 黄色 XLB40-M Yellow	
			XLB40-M.S.R	XLB40-M 红色 XLB40-M Red	
			XLB40-M.S.B	XLB40-M 黑色 XLB40-M Black	
			98034.PG	XLB40 后盖 XLB40 Back cover	
XLB40PB-M	XLB40PB-M 成品 XLB40PB-M finished product		XLB40PB-M .S.Y	XLB40PB-M 黄色 XLB40PB-M Yellow	
			XLB40PB-M .S.R	XLB40PB-M 红色 XLB40PB-M Red	
			XLB40PB-M .S.B	XLB40PB-M 黑色 XLB40PB-M Black	

XLB40PB-M

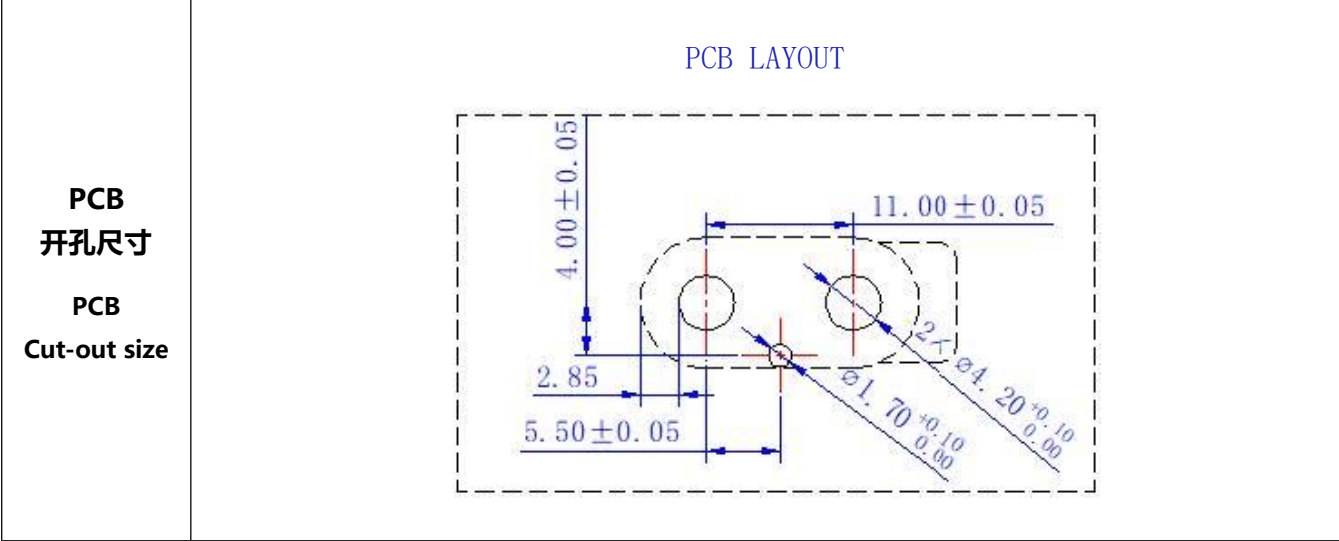

【使用说明：详细参考艾迈斯第四代产品使用手册 Instructions for use; Please refer to the user manual of the fourth generation product of AMS for details】

 <p>请勿在向连接器施加外力的状态下使用 Do not use under external force applied to the connector</p>	<ul style="list-style-type: none"> • 请勿在连接器和电线受力的状态下通电。如受到过大的外力，会破损导致故障和事故发生，所以请勿在此情况下使用。 Do not power on the connector and wires when they are under stress. If subjected to excessive external force, it may damage and cause malfunctions and accidents, so please do not use it in this situation. • 连接器是作为电路的连接部件而设计，请勿将连接器作为外壳等结构物体的一部分使用。 Connectors are designed as connecting components for circuits, and should not be used as part of structural objects such as casings. 	 <p>请小心使用 Please use with caution</p> <ul style="list-style-type: none"> • 连接器是精密部件，请在使用时谨慎小心。 Connectors are precision components, please be cautious when using them. • 请您从打开包装时起就要谨慎小心，即使是有载带和包装管这样包装的产品，它在受到强烈撞击后，还是会造成端子变形、弯曲、脱出等现象发生。 Please be cautious and careful from the moment you open the packaging. Even products packaged with carrier tapes and packaging tubes can still cause deformation, bending, and detachment of terminals after strong impact.
---	---	--

【运输和贮存 Transportation and storage】

- 产品应贮存在清洁、干燥的环境下，库房周边不存在酸、碱或其他腐蚀性气体。
The product should be stored in a clean and dry environment, and there should be no acidic, alkaline, or other corrosive gases around the warehouse.
- 产品存储温度为-10℃ ~ 40℃，相对湿度≤80%。
The storage temperature of the product is -10 °C to 40 °C, and the relative humidity is ≤ 80%.
- 产品镀银件应避光、封口密封贮存，严禁长时间空气暴露或与硫化物接触，杜绝裸手触摸。
Silver plated products should be stored away from light, sealed, and sealed. Prolonged exposure to air or contact with sulfides is strictly prohibited, and touching with bare hands is strictly prohibited.
- 产品可适用于常规交通工具运输，运输中应避免碰撞、剧烈振动、雨雪淋袭、水浸等。
The product is suitable for transportation by conventional means of transportation, and collision, severe vibration, rain and snow, water immersion, etc. should be avoided during transportation.

常州市艾迈斯电子有限公司

Changzhou ams Electronics Co., Ltd

电话: 86-0519-86731695

Tel: 86-0519-86731695

邮箱: hzy@china-amass.com

E-mail: hzy@china-amass.com

网址: www.china-amass.com

Web: www.china-amass.com

地址: 江苏常州市武进礼嘉镇新辰村委

Add: Xincheng Village Committee, Lijia Town, Wujin, Changzhou, Jiangsu



扫码了解更多

Scan the QR code
to learn more